

# DEVELON

Crawler Excavators

# DX255LC-7



Maximum power	189 hp
Operating weight	25.7 t
Bucket capacity	1.40 m <sup>3</sup>





DEVELON



DEVELON





DEVELON DX255LC-7 CRAWLER EXCAVATOR:  
**MEET THE NEW GENERATION  
OF DEVELON MACHINES**

Lift your business to the next level with the  
DX255LC-7 Develon excavator.

Exceptionally powerful, yet environmentally friendly, the  
DX255LC-7 excavator features extraordinary fuel efficiency.



# RAISE PROFITS, PRODUCTIVITY & FUEL EFFICIENCY

## RELIABILITY

Reinforced castings and forged steel pivot points and reinforced heavy-duty arm and boom to withstand high-impact materials. Monoboom or articulated boom for added versatility. Improved hydraulic line routing to protect your investment.

## VERSATILITY

A new attachment mode, with a priority valve on the attachment, results in higher working efficiency when moving the arm and using the attachment at the same time. A specific tiltrotator mode, for more precision and less back pressure when high flow is required.

## YOUR SAFETY IS OUR PRIORITY

Rear and right side cameras as standard, anti-slip steps and platforms, as well as guard rails on upper structure. Optional: a 360° all-around view camera (AVM) can be linked with unique ultrasonic detection for maximum safety while working with people around. Large side mirrors, 8 powerful LED work lights (4 additional lights possible as an option), travel alarm.

## PRODUCTIVITY

State-of-the-art bucket and arm digging forces. Delivers higher productivity and reduced fuel consumption in an efficient and comfortable work environment.

## UNDERCARRIAGE DURABILITY

Forged steel and deep-hardened top rollers – oil-lubricated rollers – heat-treated sprocket – deep-hardened, heat-treated, grease-lubricated & longer life track chains.

## EXCELLENT STABILITY

Increased counterweight for using heavy attachments.



## UNRIVALLED COMFORT

One of the most spacious cabs in the market, with low noise & vibration levels and excellent all-round visibility. Thanks to the heating and even an optional cooling functionality of the premium seat and improved air ventilation in the DX255LC-7, you can focus on the job at hand in any situation.

## OPERATE AT EASE

New Develon Smart Touch screen, an easy to read and use 8" touch screen integrates all functions and settings of your machine in one place. Don't miss any important call thanks to the hands-free phone system. And forget fumbling with keyholes: unlock the door remotely, and start or stop the engine with the included Develon Smart Key.

## ENGINE

Exceptionally powerful – with high torque at low revs – the new Develon engine combines reliability and low environmental impact. This Stage V compliant 6 cylinder engine delivers 141.3 kW at 1900 rpm.

## FULL CONTROL OVER FUEL CONSUMPTION

The latest evolution of the legendary Stage V Develon DLo6V engine achieves greater fuel savings thanks to D-Eco Power and the 3<sup>rd</sup> generation of Smart Power Control (SPC<sub>3</sub>) Take full control over your fuel consumption with the settable engine shut off.

## EASY MAINTENANCE

Maintenance data directly available from control panel. Easy access to all filters from ground level. Cooling compartment equipped with fine mesh for the intake air, to protect coolers and minimize downtime.

## ADVANCED FILTRATION

Highest efficiency filters & cleaners remove water, dust & particles to protect your investment optimally.



**Available undercarriages:**  
3200 mm standard track width  
3000 mm narrow track width





## D·ECOPOWER

**Real breakthrough technology that sets new standards in the industry:** The exclusive ECO power system improves productivity and saves fuel. A pressure-controlled pump, closed-center main control valve and 9 sensors electronically detect and control the precise amount of hydraulic oil required to perform a task and precisely meter the amount of oil required (rather than continuously forcing a fixed amount of

oil through the system), thereby improving efficiency. The hydraulic system output requirements are optimized with engine horsepower. The resulting efficiency sharply improves productivity and reduces fuel consumption. Improved feedback through the controls results in an outstanding level of operator comfort and much smoother machine control.



# TOP PERFORMANCE AND FUEL EFFICIENCY

## THE POWER TO RAISE PRODUCTIVITY

- The DX255LC-7 is equipped with the latest generation Develon engine
- Stage V compliant, this engine boasts extremely low emissions because reducing our environmental impact is paramount to us
- Exhaust gases are purified by Selective Catalytic Reduction (SCR) technology, a Diesel Oxidation Catalyst (DOC) and a Diesel Particulate Filter (DPF) with no maintenance before 8000 hours

## EFFICIENT FUEL MANAGEMENT

- Choice of 4 power modes (Eco - Standard - Power - Power Plus) and automatic Smart Power Control system for optimal power and reduced fuel consumption in all conditions
- Engine auto-shut-off: shuts down the engine after the machine has been idling for a specified time. The operator can set the delay before shut-off via the Develon Smart Touch screen

## VARIABLE PRESSURE TURBOCHARGER

Provides optimal air flow to the engine combustion chamber under all speed and load conditions, so that exhaust gas is cleaner and fuel economy is improved.

## SPC3 (SMART POWER CONTROL)

2 systems (Variable Speed Control and Pump Torque Control) work together to improve efficiency while maintaining productivity. The system reduces the engine speed and adjusts the pump torque according to work conditions.

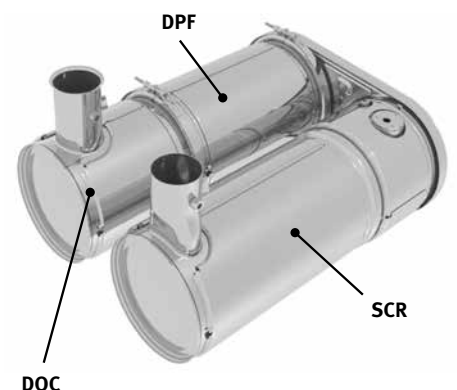





# RELIABILITY – THE HABIT OF A LIFETIME

In your profession, you need equipment you can depend on. At Develon, we put durability and reliability at the core of our machines' development. Our materials and structures undergo stringent testing for strength and resilience under the most extreme conditions.



# DESIGNED FOR LONG-TERM, ALL-ROUND, HEAVY-DUTY PERFORMANCE

## EXTRA-STRONG X CHASSIS

Designed using finite element analysis and 3D computer simulation, the X shaped undercarriage ensures optimum structural integrity and durability.

## UNDERCARRIAGE DURABILITY

- The chain is composed of sealed, self-lubricating links for long-term dependability.
- The track spring and idler are joined for long-lasting performance and easy maintenance
- Cast steel heavy-duty sprockets guarantee the highest resistance
- The track rollers are lubricated for life

## STRENGTHENED BOOM AND ARM

During the development of our machines, we use intensive testing to calculate the best load distribution throughout the boom structure.

Combined with thicker material, this means that element fatigue is limited and both reliability and component life are increased. To better protect the base of the arm, reinforced bars have been added and the arm center and end boss have been strengthened.

## ADVANCED FILTRATION

- Fuel filters and water separator: a filter-type high-performance water separator effectively captures moisture in the fuel, reducing impurities and helping minimize any fuel-related issues. Pre-filters and dual main filters as standard achieve a high degree of purity that minimizes fuel system failures.
- Cyclonic air pre-cleaner: air filter life and engine efficiency are directly related to the amount of debris ingested through the engine's air intake. Therefore, a cyclonic air pre-cleaner (as standard) is the first stage of an air intake system that prevents the majority of heavier-than-air particles from entering. Self-cleaning and maintenance-free, the system is able to expel all types of mixed debris, including mud, snow, rain, leaves, sawdust, chaff, etc.

## PIN AND BUSHING ADVANCED TECHNOLOGY

Highly lubricated metal is used for the boom pivot to increase the component's lifetime and lengthen greasing intervals. The bucket pivot features EM (Enhanced Macrosurface) bushings. These have a tailored surface pattern and self-lubricating coating for optimized greasing and more efficient debris removal. Ultra-hard wear-resistant discs and bucket pivot polymer shims increase durability even more.





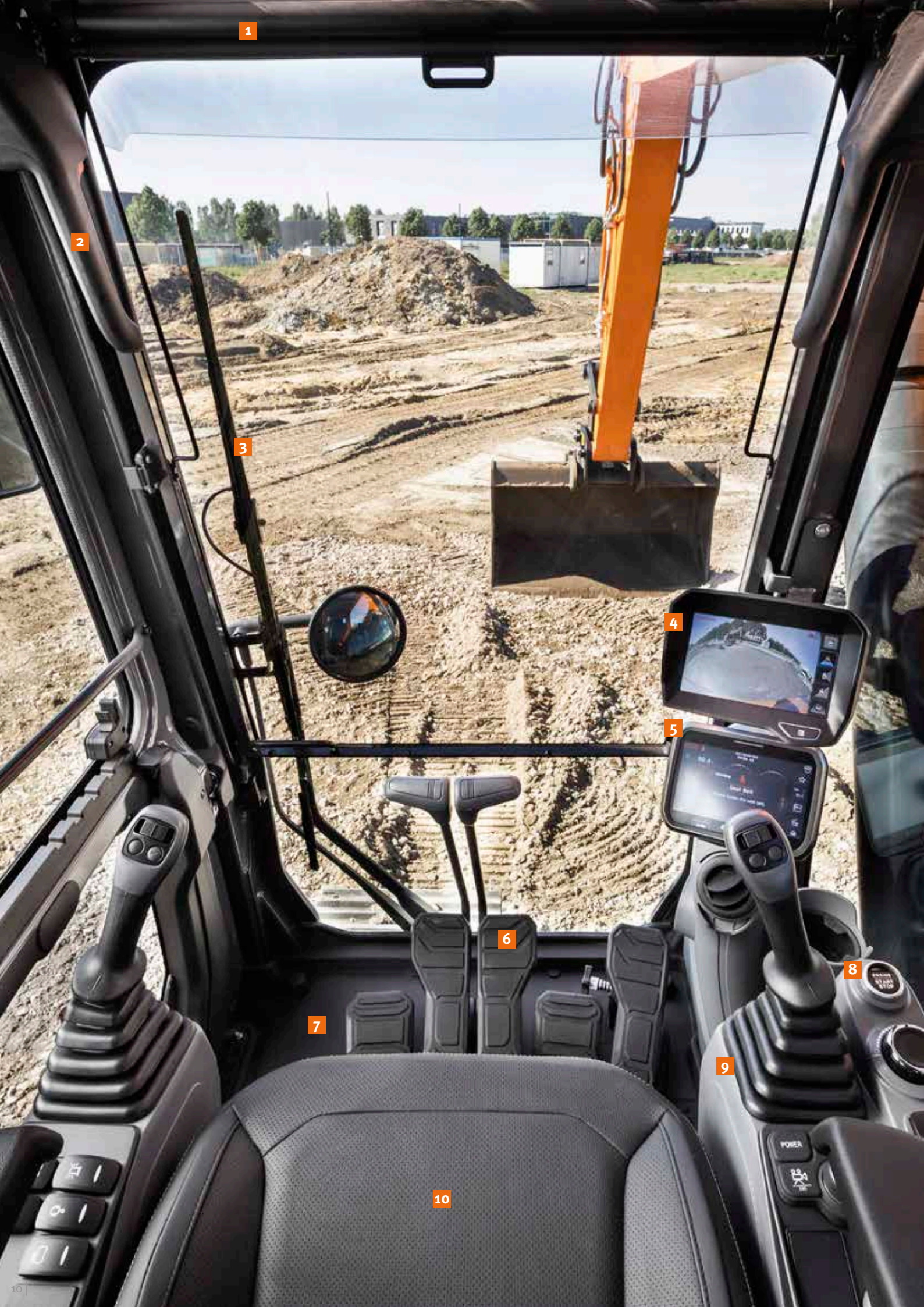

1

2

3

4

5

6

7

8

9

10



1. Sun visor
2. Window grip
3. Parallel wiper
4. 360° all-around view camera (AVM) (optional)
5. Develon Smart Touch
6. Redesigned pedals
7. Flat, spacious, easy-to-clean floor
8. Keyless start (Develon Smart Key)
9. Joysticks and switches are integrated in adjustable control consoles
10. Heated and cooled (option) seat
11. Improved visibility on the bottom right
12. Storage compartment for sunglasses
13. Separate seat height adjustment lever and cushion tilting function

# OPERATING IN HIGH COMFORT

## BEST-IN-CLASS OPERATOR ENVIRONMENT

The DX255LC-7 is designed to provide you with the best possible working conditions. The sophisticated state-of-the-art ROPS cab is pressurized and ISO-certified for your safety. A high-quality heated seat (and even seat cooling available as an option) with air suspension provides maximum operator comfort.

## UNRIVALLED COMFORT

Comfortably seated, you benefit from a clear all-round view of the work site and have easy access to several storage compartments. Pedals, joysticks and armrests have all been designed for operator comfort and efficiency. Noise and vibration levels are remarkably low, and the effectiveness of the air conditioning and automatic climate control has been increased significantly. These features allow you to continue working for hours on end without feeling tired.

Finally, thanks to the hands-free system, you won't miss any important call, and you'll stay available to your customers, as you operate the machine.

## CAB SUSPENSION

The cab's suspension system (CabSus mount) dampens vibrations and provides outstanding protection against impact. This system absorbs shocks and vibrations much more effectively than a conventional silentblock suspension system.

## DEVELON SMART TOUCH

The wide 8" touchscreen provides easy scrolling through the different menus, including power settings and auxiliary hydraulics settings. It also allows you to connect a Bluetooth device or listen to your favorite radio station.

## 360° ALL-AROUND VIEW CAMERA (AVM) SYSTEM (OPTION)

The 360° all-around view camera (AVM) system gives you full view of the machine's surroundings.

11

12

13







# TAKE A SEAT IN BUSINESS CLASS

The ergonomic controls, the easy-to-view color monitor, and Develon Smart Touch place the machine firmly in your hands.



# TOTAL CONTROL IN ALL SIMPLICITY

## DYNAMIC POWER MANAGEMENT

- Automatic travel speed range selection (slow/fast)
- Activating the power boost control system increases digging force by 10%
- A 1-touch deceleration button immediately reduces engine speed to low idle
- Auto-idling starts 4 seconds (adjustable) after all controls are returned to neutral – reducing fuel consumption and noise levels in the cab

## INTELLIGENT FLOATING BOOM MODE (OPTIONAL)

The “intelligent floating boom” function allows the boom to move up and down freely according to the application:

- Hydraulic breaker setting: during boom down operation, the boom moves down freely under its own weight. The result is reduced shock and vibration and longer breaker service life
- Full float setting: during boom down selection, the boom is allowed to rise and fall as required while the bucket is drawn across the ground

## NEW FINE SWING FUNCTION

Another new standard feature is the Fine Swing function. This function minimizes the shaking that a lifted object undergoes at the start or stop of the excavator's swing movement – increasing the safety of nearby workers and preventing damage caused by the object falling from the excavator. When Fine Swing activates, the overrun shuts off, allowing the DX255LC-7 to smoothly reach maximum swing speed and removing the shock from the turn reversal at the moment of stopping - resulting in a smooth stop.

## 4 WORK MODES AND 4 POWER MODES

These modes deliver the needed power, according to your specific application, while minimizing fuel consumption:

- Work modes: 1-way mode, 2-way mode, Digging mode and Lifting mode  
With the 2-way mode, we now have a priority valve on the attachment line to increase the machine's productivity when using an attachment and moving the arm at the same time. A new mode is also available: dedicated for tilt rotator use, to maximize precision and minimize back pressure.
- Power modes: Power Plus mode, Power mode, Standard mode, Economy mode

## EXPERT FINGERTIP CONTROL

- The new multi-function 8" Develon Smart Touch screen displays all useful information in a visual and intuitive format.
- At a glance, you can check the machine's status and settings to achieve optimal efficiency.
- Develon's unique jog shuttle switch gives you easy and precise control over all machine functions.
- Highly sensitive and low-effort joysticks enable you to work safely, smoothly and confidently.
- The proportional thumb switches on the joysticks can be mounted horizontally or vertically, as the operator prefers, for optimal control of hydraulic attachments.









# SIMPLE MAINTENANCE FOR MAXIMUM UPTIME

## MAINTENANCE ACCESS MADE SIMPLE

- Large guard rails are installed along with anti-slip steps and plates, for safer, easier access to the whole upper structure.
- The air conditioning filter is placed on the side of the cab for easy access. The filter's cover can be locked and opened with a key.
- A battery cut-off switch makes it easy to disconnect the battery for long-term storage.
- The hour meter display can be easily checked from ground level.
- Shut-off valves have been fitted on the pre-filter piping line and fuel tank drain piping to make servicing easier and prevent pollution from leakage.
- Engine parts can be easily reached via the top and side panels.
- For extra accessibility and servicing convenience, all filters (engine oil filter, fuel pre-filters, fuel filters and pilot filter) are located in the pump compartment.
- An electric transfer pump for initial priming of fuel filters is featured as standard.
- Fine mesh on the side doors and on the cooler itself filters the intake air going to the cooler for better cooling performance and reduced maintenance.

## ADBLUE® TANK

Connected to the ECU, sensors in the tank detect low levels of AdBlue® or any other system malfunction. Also equipped with an AdBlue® level indicator during refilling (LED light), to avoid over filling.

## CENTRALIZED GREASING POINTS

To make maintenance easier, the greasing points have been centralized. An automatic lubrication system is available as an option.





# TECHNICAL SPECIFICATIONS

## ENGINE

Designed to deliver superior performance and fuel efficiency, the Develon DLo6V diesel engine fully meets the latest Stage V emission regulations. To optimize machine performance, the engine uses high-pressure fuel injectors, air-to-air inter-cooler and electronic engine controls. 4-Cycle Water-Cooled, Wastegate Turbocharged, Diesel Oxidation Catalyst (DOC) & Selective Catalytic Reduction (SCR) and Diesel Particulate Filter (DPF).

### Model

Develon DLo6V

### No. of cylinders

6

### Rated power at 1900 rpm

Gross power (SAE J1995): 141.3 kW (189 hp)

Net power (SAE J1349): 138 kW (185 hp)

### Max. torque at 1400 rpm

82 kgf·m

### Idle (low - high)

800 [±50] - 2000 [±50] rpm

### Displacement

5890 cm<sup>3</sup>

### Bore × stroke

100 mm × 125 mm

### Starter

24 V / 6 kW

### Batteries – alternator

2 × 12 V, 150 Ah – 24 V, 100 A

### Air filter

Double element air cleaner and pre-filtered Cyclone Turbo dust separator

## UNDERCARRIAGE

Extremely robust construction throughout - made of high-quality, durable materials, with all welded structures designed to limit stresses.

- Track rollers lubricated for life
- Idlers and sprockets fitted with floating seals
- Track shoes made of induction-hardened alloy with triple grouser
- Heat-treated connecting pins
- Hydraulic track adjuster with shock-absorbing tension mechanism

### Upper rollers (standard shoe)

2

### Lower rollers

10

### Number of links & shoes per side

51

### Link pitch

190 mm

## HYDRAULIC SYSTEM

The e-EPOS (Electronic Power Optimising System) is the brain of the excavator – minimising fuel consumption and optimizing the efficiency of the hydraulic system for all working conditions. To harmonize the operation of the engine and the hydraulics, the e-EPOS is connected to the engine's electronic control unit (ECU) via a data transfer link. The new hydraulic system D-Eco Power, electronically controlled, delivers the exact amount of flow needed without any loss of energy.

- 2 travel speeds offer either increased torque or high speed
- Cross-sensing pump system for fuel savings
- Auto-deceleration system
- 4 operating modes, 4 power modes
- Flow and pressure control of auxiliary hydraulic circuits from control panel
- Computer-aided pump flow control

### Main pumps

2 × variable displacement tandem axial piston pumps

Maximum flow at 1900 rpm 2 × 220 l/min

### Pilot pump

Gear pump

Maximum flow at 1900 rpm 28.5 l/min

### Relief valve settings

Implement 350 kgf/cm<sup>2</sup>

Travel 350 kgf/cm<sup>2</sup>

Swing 275 kgf/cm<sup>2</sup>

Pilot 40 kgf/cm<sup>2</sup>

## HYDRAULIC CYLINDERS

High-strength steel piston rods and cylinder bodies. Shock-absorbing mechanism fitted in all cylinders for shock-free operation and extended piston life.

Cylinders	Quantity	Bore × rod diameter × stroke (mm)
Mono boom	2	130 × 90 × 1365
Articulated boom, lower	2	130 × 90 × 1335
Articulated boom, upper	1	160 × 100 × 1300
2.5 m arm	1	140 × 100 × 1655
3.0 m / 3.5 m arm	1	140 × 100 × 1655
Bucket	1	125 × 85 × 1080



## CAB

The air-conditioning and heating systems are integrated for optimal climate control. An automatically-controlled fan supplies the pressurized and filtered cab air, which is distributed throughout the cab from multiple vents.

The heated air suspension, adjustable operator's seat includes a seat belt. The operator can adjust the ergonomic seat and joystick console separately according to his preferences.

### **A-weighted emission sound pressure level at the operator's position, LpAd (ISO 6396:2008)**

Declared: 70 dB(A)

Measured: 69 dB(A)

### **A-weighted sound power level, LwAd (2000/14/EC)**

Declared: 103 dB(A)

Measured: 102 dB(A)

## SWING MECHANISM

The swing mechanism uses an axial piston motor, driving a 2-stage planetary reduction gear bathed in oil for maximum torque.

- Swing bearing: single-row, shear type ball bearing with induction hardened internal gear
- Internal gear and pinion immersed in lubricant

### **Maximum swing speed**

10.01 rpm

### **Maximum swing torque**

9880 kgf·m

## FLUID CAPACITIES

Fuel tank	420 l
Cooling system (radiator)	35.7 l
AdBlue® (DEF) tank	31.5 l
Hydraulic oil tank	250 l
Engine oil	27 l
Swing drive	7 l
Travel device	2 × 7 l

## DRIVE

Each track is driven by an independent, high-torque axial piston motor through a planetary reduction gearbox. Two levers / foot pedals guarantee smooth travel with counter-rotation on demand. The track frame protects the travel motor, brake and planetary gears. The multi-disc track brakes are spring-applied and hydraulic released.

### **Travel speed (low - high)**

3.2 - 5.6 km/h

### **Maximum traction**

28.5 t

### **Maximum gradeability**

35° / 70%

## WEIGHT

	Shoe width (mm)	Machine weight (t)	Ground pressure (kgf/cm <sup>2</sup> )
Triple grouser	600 (Std)	26.3	0.56
	700	26.6	0.49
	800	26.9	0.43
	900	27.2	0.39

## COMPONENT WEIGHTS

Item	Unit	Weight	Remarks
Upper structure without front	kg	11925	With counterweight
Lower structure assembly	kg	8959	
Counterweight	kg	5000	
Front assembly	kg	4880	
Mono boom	kg	1855	Including bushing
Articulated boom	kg	2369	
2.5 m arm	kg	701	
3.0 m arm	kg	855	
3.5 m arm	kg	950	



# TECHNICAL SPECIFICATIONS

## BUCKETS

Bucket Type	Capacity (m <sup>3</sup> ) SAE	Width (mm)		Weight (kg)	Standard track / narrow track					
		With side cutters	W/O side cutters		Mono boom			Articulated boom		
					Arm 2.50 m	Arm 3.00 m	Arm 3.50 m	Arm 2.50 m	Arm 3.00 m	Arm 3.50 m
GP	0.51	772	722	529	A / A	A / A	A / A	A / A	A / A	A / A
	0.81	1128	1064	654	A / A	A / A	A / A	A / A	A / A	A / A
	0.92	1236	1173	697	A / A	A / A	A / A	A / A	A / A	A / A
	1.05	1372	1309	751	A / A	A / A	A / A	A / A	A / A	A / A
	1.10	1377	1316	836	A / A	A / A	A / A	A / A	A / A	A / B
	1.17	1493	1430	809	A / A	A / A	A / B	A / A	A / B	A / B
	1.28	1607	1544	976	A / A	A / B	B / C	A / B	B / C	B / C
	1.40	1668	1607	848	A / A	A / B	B / C	A / B	B / C	C / C
HD	0.73	982	916	732	A / A	A / A	A / A	A / A	A / A	A / A
	0.90	1130	1064	804	A / A	A / A	A / A	A / A	A / A	A / A
	1.07	1286	1220	864	A / A	A / A	A / A	A / A	A / A	A / B
	1.24	1438	1372	923	A / A	A / B	B / B	A / A	A / B	B / C
	1.32	1516	1450	967	A / A	A / B	B / C	A / B	B / C	C / C
	1.49	1666	1600	1039	A / B	B / C	C / D	B / C	C / D	C / D
H Class	0.6	-	750	651	A / A	A / A	A / A	A / A	A / A	A / A
	0.76	-	900	722	A / A	A / A	A / A	A / A	A / A	A / A
	0.92	-	1050	813	A / A	A / A	A / A	A / A	A / A	A / A
	1.08	-	1200	884	A / A	A / A	A / A	A / A	A / A	A / B
	1.24	-	1350	955	A / A	A / B	B / B	A / A	B / B	B / C
	1.35	-	1450	1023	A / A	B / B	B / C	A / B	B / C	C / D
	1.40	-	1500	1046	A / B	B / C	C / C	B / B	C / C	C / D
	1.51	-	1600	1114	B / B	C / C	C / D	B / C	C / D	D / D

A: Suitable for materials with a density less than or equal to 2100 kg/m<sup>3</sup>

B: Suitable for materials with a density less than or equal to 1800 kg/m<sup>3</sup>

C: Suitable for materials with a density less than or equal to 1500 kg/m<sup>3</sup>

D: Suitable for materials with a density less than or equal to 1200 kg/m<sup>3</sup>

Based on ISO 10567 and SAE J296, arm length without quick-coupler. For reference only.

## DEVELON BUCKETS

4 More. More choice - More durable - More strength - More performance!

### General Construction Bucket



The General purpose bucket is designed for digging and re-handling soft to medium materials (e.g. materials with low wear characteristics such as top-soil, loam, coal).

### Heavy Construction Bucket



The Heavy duty bucket is designed for mass excavations in dense materials such as hard packed clay, shot limestone, limited rock content and gravel.

### Severe Mining Bucket



The Severe duty bucket is designed for durability in digging compact materials like loose or blasted rock, hard packed clay and stone.

### X-treme Mining Bucket



The X-treme duty bucket is designed as a long-life version of the Severe duty bucket for digging in the most abrasive materials.



# DIMENSIONS

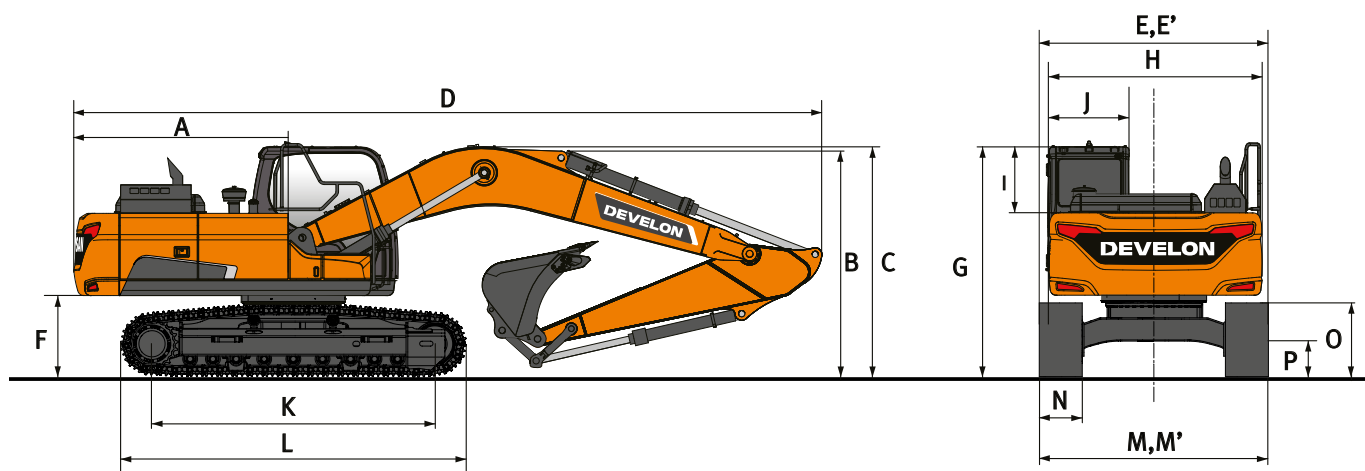

## DIMENSIONS

	Unit	Mono boom			Articulated boom		
<b>Boom length</b>	<b>mm</b>	<b>5900</b>			<b>6090</b>		
<b>Arm length</b>	<b>mm</b>	<b>2500</b>	<b>3000</b>	<b>3500</b>	<b>2500</b>	<b>3000</b>	<b>3500</b>
<b>Bucket capacity</b>	<b>m<sup>3</sup></b>	<b>1.17</b>	<b>1.10</b>	<b>0.92</b>	<b>1.17</b>	<b>1.10</b>	<b>0.92</b>
A Tail swing radius	mm	3040	3040	3040	3040	3040	3040
B Shipping height (boom)	mm	3085	2995	3380	3095	3115	3460
C Shipping height (hose)	mm	3300	3200	3555	3095	3115	3500
D Shipping length	mm	10145	10080	10105	10285	10260	10190
E Shipping width std	mm	3200	3200	3200	3200	3200	3200
E' Shipping width narrow	mm	3000	3000	3000	3000	3000	3000
F Counterweight clearance	mm	1110	1110	1110	1110	1110	1110
G Height over cab	mm	2995	2995	2995	2995	2995	2995
H House width	mm	2710	2710	2710	2710	2710	2710
I Cab height above house	mm	840	840	840	840	840	840
J Cab width	mm	1010	1010	1010	1010	1010	1010
K Tumbler distance	mm	3835	3835	3835	3835	3835	3835
L Track length	mm	4630	4630	4630	4630	4630	4630
M Undercarriage width std	mm	3200	3200	3200	3200	3200	3200
M' Undercarriage width narrow	mm	3000	3000	3000	3000	3000	3000
N Shoe width std.	mm	600	600	600	600	600	600
O Track height	mm	990	990	990	990	990	990
P Ground clearance *	mm	450	450	450	450	450	450

\* : without grouser



# WORKING RANGE

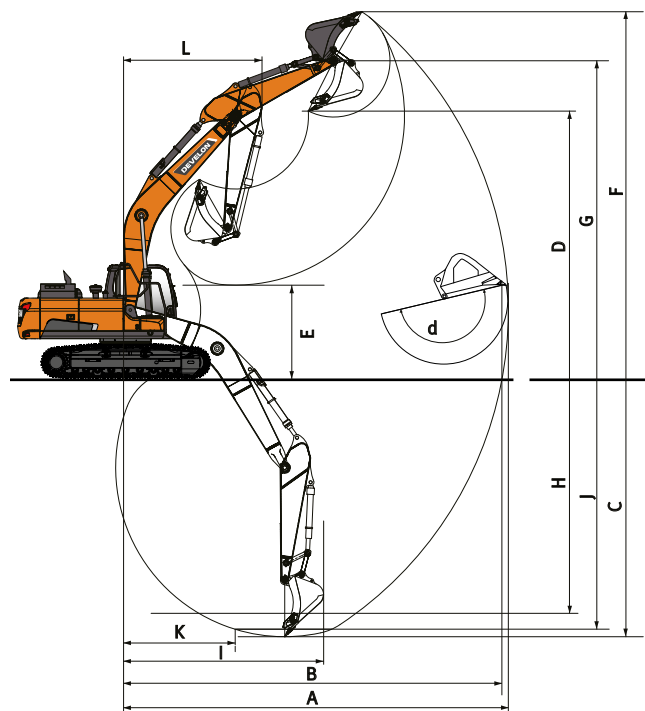

## WORKING RANGE

	Unit	Mono boom			Articulated boom		
<b>Boom length</b>	<b>mm</b>	<b>5900</b>			<b>6090</b>		
<b>Arm length</b>	<b>mm</b>	<b>2500</b>	<b>3000</b>	<b>3500</b>	<b>2500</b>	<b>3000</b>	<b>3500</b>
<b>Bucket capacity</b>	<b>m<sup>3</sup></b>	<b>1.17</b>	<b>1.10</b>	<b>0.92</b>	<b>1.17</b>	<b>1.10</b>	<b>0.92</b>
A Max. digging reach	mm	9650	10175	10605	9950	10485	10935
B Max. digging reach (ground)	mm	9455	9995	10430	9765	10310	10765
C Max. digging depth	mm	6310	6810	7315	6205	6735	7210
D Max. loading height	mm	6650	7025	7170	8155	8645	8960
E Min. loading height	mm	3100	2600	2090	4100	3500	3090
F Max. digging height	mm	9275	9705	9820	11030	11545	11850
G Max. bucket pin height	mm	8120	8500	8640	9625	10115	10430
H Max. vertical wall depth	mm	4450	5200	5520	4655	4680	5645
I Max. radius vertical	mm	7215	7225	7520	7235	7765	7560
J Max. digging depth (8' level)	mm	6060	6615	7135	6090	6630	7100
K Min. radius 8' level	mm	2845	2930	2945	1675	1675	1735
L Min. swing radius	mm	3730	3720	3745	3080	2935	3285
d Bucket angle	°	174	174	174	174	174	174

## DIGGING FORCES (ISO)















	Unit	Mono boom			Articulated boom		
<b>Boom length</b>	<b>mm</b>	<b>5900</b>			<b>6090</b>		
<b>Arm length</b>	<b>mm</b>	<b>2500</b>	<b>3000</b>	<b>3500</b>	<b>2500</b>	<b>3000</b>	<b>3500</b>
<b>Bucket capacity</b>	<b>m<sup>3</sup></b>	<b>1.17</b>	<b>1.10</b>	<b>0.92</b>	<b>1.17</b>	<b>1.10</b>	<b>0.92</b>
BUCKET (Normal/Press. Up)	ton	17.0 / 17.9	17.0 / 17.9	17.0 / 17.9	17.0 / 17.9	17.0 / 17.9	17.0 / 17.9
ARM (Normal/Press. Up)	ton	14.6 / 15.4	12.1 / 12.8	11.1 / 11.7	14.6 / 15.4	12.1 / 12.8	11.1 / 11.7



# LIFTING CAPACITIES

STANDARD TRACK WIDTH: 3200 MM • W/O BUCKET

(UNIT: 1000 KG)

A	1.5 m		3.0 m		4.5 m		6.0 m		7.5 m		9.0 m		Max. reach		
															A

**Mono boom • Arm 3.00 m • Shoe 600 mm • Counterweight 5.0 t**

7.5 m								6.40 *	6.40 *					5.12 *	5.12 *	6.64
6.0 m								6.54 *	6.54 *	5.68 *	4.93			4.84 *	4.73	7.67
4.5 m								7.29 *	6.87	6.66 *	4.85			4.81 *	4.10	8.31
3.0 m						10.89 *	10.03	8.37 *	6.55	7.02	4.70			4.96 *	3.78	8.64
1.5 m						12.89 *	9.40	9.41 *	6.24	6.85	4.55			5.29 *	3.67	8.70
0.0 m			7.28 *	7.28 *	13.80 *	9.08	9.37	6.03	6.73	4.44				5.64	3.75	8.49
-1.5 m	8.35 *	8.35 *	12.68 *	12.68 *	13.69 *	9.00	9.27	5.95	6.68	4.40				6.12	4.05	8.00
-3.0 m	13.90 *	13.90 *	17.53 *	17.53 *	12.62 *	9.08	9.32	5.98						7.21	4.74	7.16
-4.5 m			13.80 *	13.80 *	10.17 *	9.33								7.38 *	6.46	5.83

**Mono boom • Arm 3.50 m • Shoe 600 mm • Counterweight 5.0 t**

7.5 m														4.60 *	4.60 *	7.20
6.0 m										5.90 *	5.00			4.40 *	4.32	8.16
4.5 m								6.72 *	6.72 *	6.22 *	4.9			4.39 *	3.78	8.76
3.0 m						9.99 *	9.99 *	7.85 *	6.61	6.78 *	4.73	4.91 *	3.55	4.52 *	3.50	9.07
1.5 m						12.21 *	9.50	9.00 *	6.27	6.86	4.55	5.21	3.47	4.82 *	3.40	9.13
0.0 m			8.42 *	8.42 *	13.49 *	9.07	9.36	6.01	6.70	4.41				5.21	3.45	8.93
-1.5 m	8.04 *	8.04 *	12.38 *	12.38 *	13.73 *	8.91	9.21	5.88	6.62	4.33				5.59	3.69	8.47
-3.0 m	12.56 *	12.56 *	18.07 *	17.85	13.03 *	8.93	9.21	5.88	6.65	4.36				6.45	4.24	7.68
-4.5 m	18.38 *	18.38 *	15.47 *	15.47 *	11.14 *	9.13	8.15 *	6.03						7.24 *	5.47	6.46



**Articulated boom • Arm 2.50 m • Shoe 600 mm • Counterweight 5.0 t**

9.0 m						8.69 *	8.69 *							8.48 *	8.48 *	4.55
7.5 m						9.42 *	9.42 *	8.56 *	7.05					7.18 *	6.40	6.34
6.0 m						9.99 *	9.99 *	8.62 *	6.99					6.74 *	4.92	7.41
4.5 m						11.72 *	10.46	9.20 *	6.72	7.13	4.76			6.32	4.21	8.07
3.0 m						13.26 *	9.63	9.83 *	6.38	6.97	4.61			5.84	3.87	8.41
1.5 m								9.50	6.08	6.81	4.47			5.70	3.76	8.47
0.0 m						12.92 *	8.88	9.30	5.91	6.71	4.38			5.87	3.86	8.26
-1.5 m						11.19 *	8.9	8.84 *	5.88	6.57 *	4.38			6.06 *	4.21	7.75
-3.0 m						8.48 *	8.48 *	6.69 *	5.99					5.08 *	5.03	6.89

**Articulated boom • Arm 3.00 m • Shoe 600 mm • Counterweight 5.0 t**

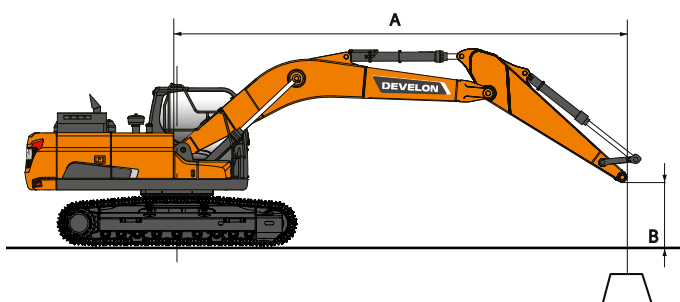
4.5 m														4.39 *	3.75	8.63
3.0 m										6.95	4.59			4.46 *	3.48	8.95
1.5 m						12.34 *	9.09	9.05 *	6.05	6.76	4.41	4.74 *	3.38	4.68 *	3.38	9.01
0.0 m						12.01 *	8.78	8.99 *	5.83	6.62	4.29			5.09 *	3.45	8.81
-1.5 m			9.72 *	9.72 *	10.73 *	8.73	8.27 *	5.76	6.31 *	4.26				5.07 *	3.73	8.33
-3.0 m	6.84 *	6.84 *	9.90 *	9.90 *	8.55 *	8.55 *	6.70 *	5.82	4.46 *	4.36				4.35 *	4.34	7.54
-4.5 m	0.16 *	0.16 *	5.15 *	5.15 *	5.07 *	5.07 *	3.46 *	3.46 *						2.83 *	2.83 *	6.28
-6.0 m	1.45 *	1.45 *	27.32 *	19.45										18.66 *	11.69	4.05



 : Rating over front.  
 : Rating over side or 360°.















- Lifting capacities are in compliance with ISO 10567:2007(E).
- The load point is at the end of the arm.
- \* = The nominal loads are based on hydraulic capacity.
- The nominal loads shown do not exceed 75% of tipping loads or 87% of hydraulic lifting capacity.
- For lifting capacity with bucket, simply subtract the actual weight of the bucket from the values.
- The configurations indicated do not necessarily reflect the standard equipment of the machine.



# LIFTING CAPACITIES

**NARROW TRACK WIDTH: 3000 MM • W/O BUCKET**

**(UNIT: 1000 KG)**

A	1.5 m		3.0 m		4.5 m		6.0 m		7.5 m		9.0 m		Max. reach		A
															

**Mono boom • Arm 2.50 m • Shoe 600 mm • Counterweight 5.0 t**

7.5 m														7.25 *	6.63	5.93
6.0 m							7.19 *	6.49						7.09 *	4.98	7.06
4.5 m						9.51 *	9.51 *	7.89 *	6.28	7.15	4.46			6.78	4.23	7.75
3.0 m					11.80 *	9.00	8.91 *	5.99	7.02	4.34				6.23	3.87	8.10
1.5 m					13.53 *	8.49	9.60	5.73	6.88	4.22				6.07	3.74	8.17
0.0 m					14.03 *	8.28	9.42	5.57	6.79	4.14				6.26	3.83	7.95
-1.5 m			13.85 *	13.85 *	13.55 *	8.26	9.36	5.52						6.89	4.19	7.42
-3.0 m			16.18 *	16.18 *	12.11 *	8.38	9.08 *	5.61						8.08 *	5.06	6.51
-4.5 m			11.86 *	11.86 *	8.89 *	8.70								7.77 *	7.51	5.00

**Mono boom • Arm 3.00 m • Shoe 600 mm • Counterweight 5.0 t**

7.5 m							6.40 *	6.40 *						5.12 *	5.12 *	6.64
6.0 m							6.54 *	6.54 *	5.68 *	4.53				4.84 *	4.35	7.67
4.5 m							7.29 *	6.31	6.66 *	4.46				4.81 *	3.76	8.31
3.0 m					10.89 *	9.10	8.37 *	5.99	7.00	4.31				4.96 *	3.46	8.64
1.5 m					12.89 *	8.50	9.41 *	5.69	6.83	4.16				5.29 *	3.36	8.70
0.0 m			7.28 *	7.28 *	13.80 *	8.18	9.34	5.49	6.71	4.05				5.62	3.42	8.49
-1.5 m	8.35 *	8.35 *	12.68 *	12.68 *	13.69 *	8.10	9.24	5.4	6.66	4.01				6.10	3.69	8.00
-3.0 m	13.90 *	13.90 *	17.53 *	15.95	12.62 *	8.18	9.29	5.44						7.19	4.33	7.16
-4.5 m			13.80 *	13.80 *	10.17 *	8.43								7.38 *	5.89	5.83

**Articulated boom • Arm 2.50 m • Shoe 600 mm • Counterweight 5.0 t**

9.0 m					8.69 *	8.69 *								8.48 *	8.48 *	4.55
7.5 m					9.42 *	9.42 *	8.56 *	6.47						7.18 *	5.87	6.34
6.0 m					9.99 *	9.99 *	8.62 *	6.42						6.74 *	4.51	7.41
4.5 m					11.72 *	9.51	9.20 *	6.15	7.11	4.36				6.30	3.86	8.07
3.0 m					13.26 *	8.70	9.80	5.82	6.95	4.21				5.82	3.54	8.41
1.5 m							9.46	5.52	6.79	4.07				5.68	3.43	8.47
0.0 m					12.92 *	7.97	9.27	5.36	6.69	3.98				5.85	3.51	8.26
-1.5 m					11.19 *	8.00	8.84 *	5.33	6.57 *	3.99				6.06 *	3.84	7.75
-3.0 m					8.48 *	8.17	6.69 *	5.44						5.08 *	4.58	6.89

**Articulated boom • Arm 3.00 m • Shoe 600 mm • Counterweight 5.0 t**

9.0 m					7.48 *	7.48 *								5.55 *	5.55 *	5.50
7.5 m							7.09 *	6.59						4.79 *	4.79 *	7.04
6.0 m					7.30 *	7.30 *	7.68 *	6.48	6.55 *	4.46				4.48 *	3.94	8.02
4.5 m					10.98 *	9.68	8.75 *	6.20	6.85 *	4.36				4.39 *	3.43	8.63
3.0 m					12.66 *	8.84	9.48 *	5.83	6.93	4.19				4.46 *	3.16	8.95
1.5 m					13.58 *	8.17	9.44	5.49	6.74	4.01	4.74 *	3.07		4.68 *	3.07	9.01
0.0 m					13.24 *	7.87	9.19	5.28	6.61	3.89				5.09 *	3.13	8.81
-1.5 m			9.72 *	9.72 *	11.86 *	7.82	9.11	5.20	6.56	3.86				5.64 *	3.38	8.33
-3.0 m					9.49 *	7.94	7.44 *	5.26	4.98 *	3.96				4.87 *	3.94	7.54





# STANDARD AND OPTIONAL EQUIPMENT

● Standard ○ Optional

## Engine

---

- Develon DLo6V, Stage V compliant, SCR, DOC and DPF post treatment, water-cooled diesel engine with Wastegate Turbocharger and air-to-air intercooler
- Auto-idle function
- Auto shut-off
- No EGR

## Hydraulic system

---

- Boom and arm flow regeneration
- Fine swing mode, on or off from cab
- Swing anti-rebound valves
- Spare ports (valve)
- One-touch power boost function
- Double way line high flow + breaker piping (PE3C)
- Smart Power Control (SPC3)
- Cylinder cushioning & contamination seals
- Double pump flow
- Clamshell piping (diverter valve from bucket cylinder)
- Hydraulic piping low flow for rotating or tilting tool (joystick control)
- Hydraulic piping for quick-coupler
- Floating boom

## Cab & interior

---

- Pressurized sound-insulated and CabSus mounted cab
- Fully adjustable air suspension seat with heater
- Air conditioning with climate control
- Pull-up type front window sun roller blind and removable lower front window
- Sliding left window
- Intermittent upper and lower windshield parallel wiper
- Rain visor
- Rear window defroster switch
- Adjustable PPC wrist control levers for arm boom bucket and swing
- Joysticks & pedals provide proportional control of auxiliary hydraulic lines
- Pedal for auxiliary control 1 & 2 ways
- Jog shuttle switch
- DEVELON Smart Touch – 8" touch screen, all-in-one
- Attachment management system
- Engine speed (RPM) control dial
- Automatic travel speed
- 4 operating modes & 4 working modes
- Multiple storage compartments (e.g. document holder under seat)
- Storage area (tools etc.)
- Heating and cooling lunch box
- Flat spacious easy-to-clean floor
- Keyless start (Develon Smart Key) & remote door lock/unlock
- Anti-theft protection
- 12 V spare power socket
- Serial communication port for laptop PC interface
- Remote radio ON/OFF switch
- Loudspeakers and connections for radio
- Radio + MP3 (stereo) with Bluetooth streaming and handsfree call system
- Rear and side view camera
- 360° all-around view camera (AVM)
- 360° all-around view camera (AVM) + ultrasonic detection
- Fully adjustable air suspension seat (heating & cooling)

## Safety

---

- Roll Over Protective Structure (ROPS)
- Boom and arm cylinder safety valves
- Overload warning device
- Large guard rails on upper structure and steps
- Rotating beacon
- Punched metal anti-slip plates
- Hydraulic safety lock lever
- Safety glass
- Hammer for emergency escape
- Right and left rear-view mirrors
- Lockable fuel cap and covers
- Battery cut-off switch
- Emergency engine stop switch and hydraulic pump control switch
- Engine restart prevention system
- Guard rails (ISO 2867:2011)
- Parking brake
- LED 8 work lights (2 boom lamp, 4 body lamps, 2 additional lamps on cab)
- LED work lights 4 additional lamps (2 in the front, 2 in the rear of the cab)
- Falling Objects Guard System – top and front cab guards (ISO 10262 level II and SAE J1356)
- Front window upper and lower guards

## Other

---

- 5900 mm boom – 3000 mm arm – 5000 kg counterweight
- DEVELON Fleet Management Web (telematic system)
- Auto shut-off fuel filler pump
- Double element air cleaner and pre-filtered Turbo dust separator
- Fuel pre-filter with water separator sensor
- Dust screen for radiator/oil cooler
- Self-diagnostic function
- Batteries (2 × 12 V, 150 Ah) – alternator (24 V, 100 A)
- Hydrostatic drive with 2-speed power shift transmission
- Remote greasing for swing circle and work group pivot points
- Arms: 2500 mm, 3000 mm, 3500 mm
- Boom: 6090 mm articulated boom
- DEVELON buckets: full range of GP, HD & rock buckets
- DEVELON breakers and DEVELON quick-couplers
- Automatic lubrication system
- 5500 kg counterweight
- Air compressor

## Undercarriage

---

- Standard fixed undercarriage 3200 mm with 600 mm shoes
- 600 mm triple grouser shoes
- 700 mm triple grouser shoes
- 800 mm triple grouser shoes
- 900 mm triple grouser shoes
- Narrow fixed undercarriage 3000 mm with 600 mm shoes





# Powered by Innovation

DISCOVER MORE:  
DX255LC-7

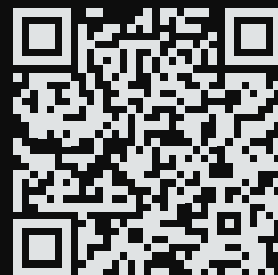

# DEVELON

DOOSAN Infracore Europe s.r.o.  
IBC - Pobřežní 620/3, 186 00 Praha 8-Karlín  
Czech Republic

©2023 DEVELON D4600913-EN (05-23)

Certain specification(s) are based on engineering calculations and are not actual measurements. Specification(s) are provided for comparison purposes only and are subject to change without notice. Specification(s) for your individual Develon equipment will vary based on normal variations in design, manufacturing, operating conditions, and other factors. Pictures of Develon units may show other than standard equipment.